









PARTS LIST

Image	Part Name	6' x 4' Greenhouse	6' x 8' Greenhouse
	Shade Net	14' x 4' 6"	14' x 8' 6"
	Eye Bolt	6	6
	Flat Washer	6	6
	Nut	6	6
	1/4" Drill Bit	1	1
	Rope	50'	50'

NOTE: Install your shade net on a calm day. It will require 2 people for installation.

1. Close all roof vents completely prior to installation.
2. Use the provided drill bit to drill a hole at the halfway point on the base kit, or if you have a longer unit space out the holes for the eyebolt about every 4 feet according to how many eyebolts came in your kit see **A**.
3. See **B**, remove the top bolt and switch to the eyebolt on both sides of the base kit.

Note: Eyebolt and flat washer on outside of base, and the nut on the inside of the base kit see diagram **C**.

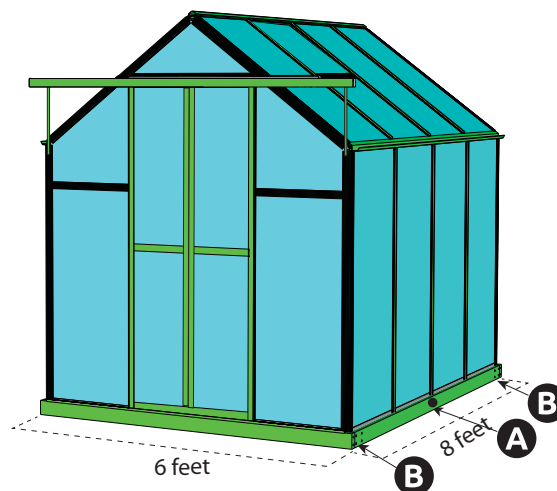
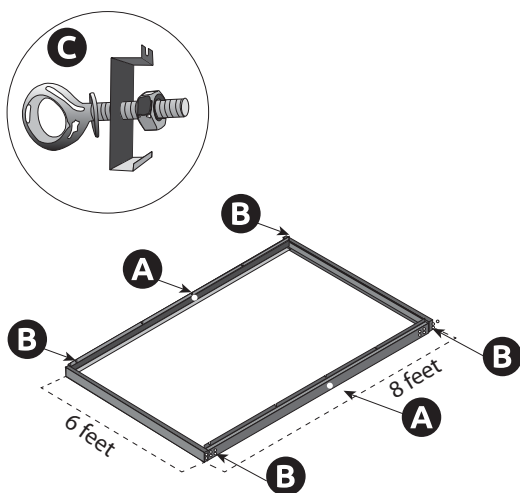

4. Place the shade net in front of your Greenhouse. The front of the shade net measures 14', fold the shade net in an accordion fashion for the easiest installation see **D**.

5. With the help of another person, lift the folded shade net and place it over the front of your greenhouse, then gently roll out across the entire greenhouse.

6. Open all Roof Vents, then use rope to tie the shade net down weaving from the grommet to the eyebolts as shown in **E**. For 1 tie a regular square knot, then at 7 tie the taut line knot, see **F**.

NOTE: Remove your shade net during seasons when not needed and store in a dry place.

