



GRANDIO[®]

G R E E N H O U S E S









Model: **GRA-BENCH-HD**

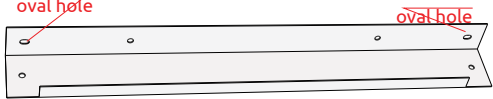

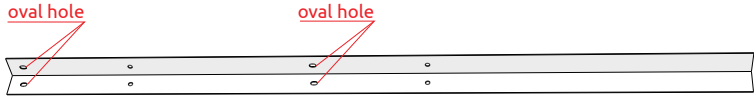
GREENHOUSE TWO TIER POTTING BENCH USER MANUAL

© 2013 Grandio Greenhouses, Backyard Living Source Inc. All rights reserved
August 8, 2017 Version

PARTS LIST

THG-01	SIDE SUPPORTS	30x40x1105	4	
THG-02	END SLATS	40x55x500	4	
THG-03	MID TABLE SLATS	15x50x500	18	
THG-04	LEG SUPPORTS	35x35x985	4	
THG-05	STRAP SUPPORTS	30x180	16	
ML01/S02	NUT & BOLT	M6*10	93	
ALLEN WRENCH	ALLEN WRENCH	4mm	1	
W11	WRENCH	10mm	1	
FOOT CAP	PLASTIC FOOT CAP		4	

DIAGRAM

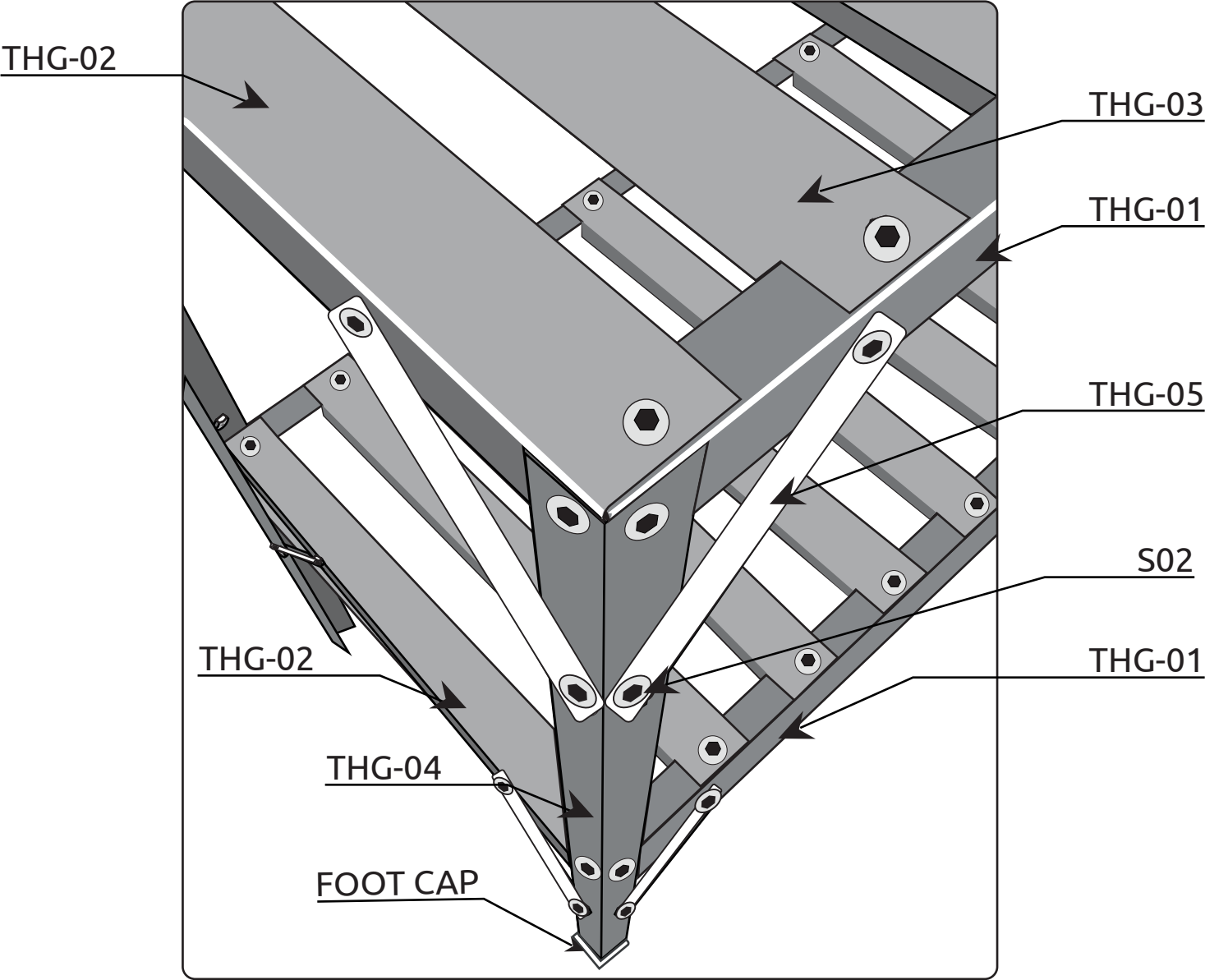

INSTRUCTIONS

1.1 Use the **W11** 10mm wrench and the **ALLEN WRENCH** to tighten the **ML01/S02** nut and bolt combination. Follow the diagrams to put your potting bench together.

1.2 Attach **THG-04** to the outside of **THG-01** and the **THG-02** using the provided bolts and nuts as shown in diagram for the top and bottom level. Repeat on all corners of the table.

1.3 Attach the (18) **THG-03's** to the (4) **THG-01's** with the **ML01/S02** nut and bolt combos as shown in the diagram. Note that the **THG-03** slats will rest on top of the **THG-01** supports on both levels of the shelf.

1.4 Attach the (16) **THG-05** brackets as shown with the **ML01/S02** nut and bolt combos on the outside of the **THG-01**, **THG-02** and **THG-04**. Repeat on both levels and all corners as shown in the diagram.

1.5 Confirm that all nut and bolt combos are tightened, then attach the (4) **FOOT CAPS** to the bottom edges of the (4) **THG-04's**.

